

Setting & Using the RS-232 Capabilities of Different Rubidium Models

CONTENTS

- 1. *RS-232 CONNECTION TYPES*..... 2
 - 1.1 Pin Layout of Different Rubidium Models 2
 - 1.2 Mapping of the PC RS-232 Pin Layout 3
- 2. *SERIAL INTERFACE OPERATION*..... 3
 - 2.1 Introduction 3
 - 2.2 RS-232 Limitations for Specific Rubidium Models 3
 - 2.3 General Instructions for Serial Interface Communications 4
 - 2.4 Understanding the Serial Interface Connection Scheme 5
 - 2.5 Monitoring the Rubidium Internal Parameters 5
 - 2.6 Adjusting/Calibrating the Frequency Center through the Serial Interface 5
 - 2.7 Reading back the Frequency Center Values 9
 - 2.8 Rubidium Identification 9
- 3. *RS-232 ADAPTER CIRCUIT* 9
- 4. *RUBIDIUM ASCII-CODE CONVERSION TABLE FOR COMMUNICATIONS*..... 10
- 5. *MICROSOFT WINDOWS 95/98 HYPERTERMINAL SETUP CONFIGURATION*..... 11

1. RS-232 CONNECTION TYPES

1.1 Pin Layout of Different Rubidium Models

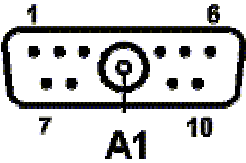
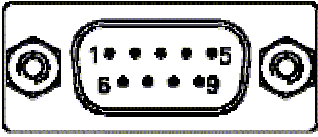
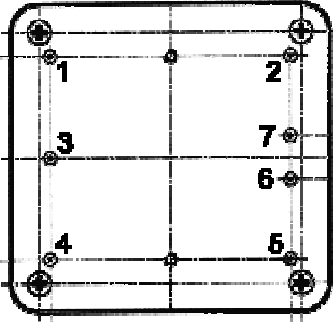
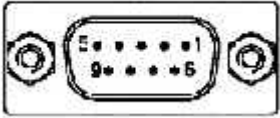
MCFRS / HPFRS / LTCRO	LPFRS	RMO ^(a)	PFRS
	<p>D-Sub 9 pins male</p> 		
<ol style="list-style-type: none"> 1. Lock Monitor 2. Frequency adjust 3. GND 4. (others). TxD (TTL) 5. RxD (TTL) 6. Heating +24V 7. (LTCRO). NC\$ 7. (others). XTAL mon. 8. Vref (+5V) 9. Power (+24V) <p>A1. Frequency output</p> <p>Use pin10 for RS232 return</p>	<ol style="list-style-type: none"> 1. +24V (+12V) 2. 0V (GND) 3. Lock indicator 4. Vref (5V reference) 5. GND 6. RS232 TxD, TTL 7. GND 8. Frequency adjust 9. RS232 RxD, TTL 	<ol style="list-style-type: none"> 1. Frequency output 2. Vref / lock indicator 3. Ground 4. Frequency control input 5. Power supply 6. RxD (TTL)(optional pin) 7. TxD (TTL)(optional pin) <p>Standard = RS-232 present.</p>	<ol style="list-style-type: none"> 2. RxD (RS232 receive, TTL) 3. TxD (RS232 transmit, TTL) 5. GND

Acronyms:

- GND: Ground
- TxD: Serial Transmit
- RxD: Serial Receive
- TTL: 0-5V Level

Note:

(a) If pins 6 and 7 are physically presents, the RMO has full RS-232 capabilities.

1.2 Mapping of the PC RS-232 Pin Layout

Function	PC connector	
	DB9	DB25
Data Carrier Detect	1	8
Receive Data	2	3
Transmit Data	3	2
Data Terminal Ready	4	20
Ground	5	7
Data Set Ready	6	6
Request To Send	7	4
Data Carrier Detect	8	5
Ring Indicator	9	22

The Rubidium clock does utilize the control lines. Thus, your terminal program must be configured to ignore them. The clock only uses Transmit, Receive and Ground data.

Be careful about RS-232 serial cables available on the market. Some cables provide the inversion of the Transmit and Receive lines, while some do not. Always verify the correct wiring. Sometimes you may plug in a NULL-MODEM inverter.

If you use BIOS level serial communication functions (re: X86 PC), like Interrupt 0x14, you may need to strap additional wires on the PC's connector side to meet the BIOS verifications. Connect RTS to CTS and DSR to DTR. For example, on a DB25 connector, strap pin 4 with pin 5 and pin 6 with pin 20 (see schematics in chapter 2.3).

2. SERIAL INTERFACE OPERATION

2.1 Introduction

The Rubidium clocks are equipped with a microcomputer, associated with multi-channel D/A converters, used for setting its parameters. The microcomputer is also used for the interrogation and detection of the Rubidium absorption 'dip'.

The integrated serial interface allows an automatic parameter adjustment during the manufacturing process as well as coarse and fine adjustments of the frequency center.

All the operating parameters are stored in an integrated EEPROM memory. In addition, a 8-channel A/D converter is used for monitoring the main internal signals such as light level, signal level, thermostat heating currents, etc.

2.2 RS-232 Limitations for Specific Rubidium Models

Typically, all Rubidium models are able to receive commands through the RS-232 port.

All the Rubidium models, but the HPFRS, can transmit information through RS-232.

Upon request, we can remove/adapt the RS-232 pins on the RMO model for full pin-to-pin compatibility with a double oven OCXO.

2.3 General Instructions for Serial Interface Communications

For serial communications with a PC:

- The following chapters describe the various commands that can be sent to the Rubidium clock through RS-232. Please note that all the commands should be sent in UPPER CASE.
- If the Rubidium clock does not understand a command, it returns a quotation mark (?) through the RS-232.
- <CR> means Carriage Return which is an ASCII decimal code 13 or hexadecimal code 0x0D.
- When using a Windows Terminal, just type the <Return> key of the keyboard.
- Do not type space characters between the command and the carriage return.

For serial communications with a microcontroller:

- The numerical value transmitted to the Rubidium clock is coded into ASCII. For example, if you want to send the Read-Back command L06, you have to send four ASCII characters: 'L', '0', '6', and 'Carriage return', which correspond in hexadecimal to: " 4C 30 36 0D ".
- An ASCII table is included in chapter 4 to help you convert your commands into hexadecimal codes.
- The SCI (Serial Communication Interface) used in the Rubidium clock is a full-duplex UART-type asynchronous system, using standard non-return-to-zero (NRZ) format (1 start, 8 data, 1 stop bit). Both the transmitter and the receiver are double buffered. The UART resynchronizes the receiver bit clock on all one-to-zero transitions in the bit stream; therefore, differences in baud rate between the sending device and the Rubidium clock are not likely to cause transmission errors.
- The coding for ASCII character is 8 bits (signed).
- After the start bit, the byte transfer begins by the LSB up to the MSB (8 bits) and ends with a stop bit.
- The theoretical worst-case cumulated baud rate frequency mismatch is 4.2%
- Typically, microcontrollers provide a TTL Tx/D signal, compatible with the Rubidium clock's Rx/D.

2.4 Understanding the Serial Interface Connection Scheme

The data transfer from the Rubidium clock can be made by direct connection to a PC or standard terminal .

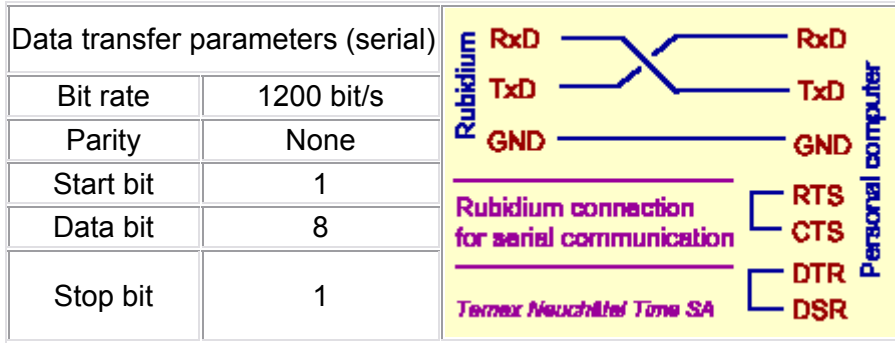

IMPORTANT NOTE:

In most cases, the serial PC interface accepts 0-5V level and a direct connection can be made. In case this 0-5V standard is not working, please refer to the small “RS-232 Adapter Circuit’ described in chapter 3 below.

WARNING:

In case of wrong connection, for example, in case of plug-in the PC transmit to the RB transmit, you may damage both the PC and Rubidium serial ports.

2.5 Monitoring the Rubidium Internal Parameters

The monitoring of the Rubidium’s internal parameters is depending on the Rubidium type you are using. The specific internal monitoring capabilities and commands of each Rubidium model are detailed in the respective Operating Manual available on the website. The HPFRS-01 internal parameters cannot be monitored.

2.6 Adjusting/Calibrating the Frequency Center through the Serial Interface

The adjustment calibration of the frequency center through the serial interface depends on the Rubidium type you are using. The specific frequency adjustment capabilities and commands of each Rubidium model are detailed in the respective Operating Manual available on the website.

Typical Calibration Diagram

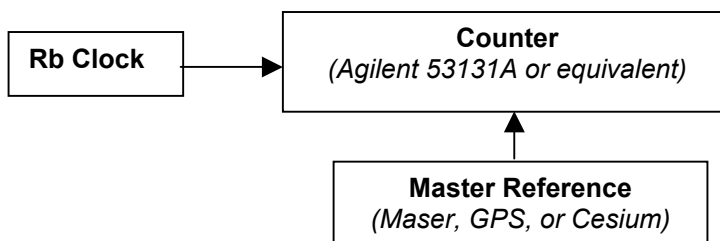

Defining the Recalibration Period

If the Rubidium has a drift rate of $1E-10$ to $2E-10$ per year and the end customer system requires $5E-10$ in absolute accuracy, the typical recalibration is 2 to 3 years.

The following table indicates the codes to send using Hyper Terminal with the associated frequency corrections.

Table 1 indicates fine turning frequency correction value for the standard pulling range of 2.5×10^{-9} full scale.

Terminal	Frequency	Terminal	Frequency	Terminal	Frequency	Terminal	Frequency
Negative Adjustment				Positive Adjustment			
<i>F00</i>	0.00E+00	<i>FC0</i>	-6.40E-10	<i>F00</i>	0.00E+00	<i>F40</i>	6.40E-10
FFF	-1.00E-11	FBF	-6.50E-10	F01	1.00E-11	F41	6.50E-10
FFE	-2.00E-11	FBE	-6.60E-10	F02	2.00E-11	F42	6.60E-10
FFD	-3.00E-11	FBD	-6.70E-10	F03	3.00E-11	F43	6.70E-10
FFC	-4.00E-11	FBC	-6.80E-10	F04	4.00E-11	F44	6.80E-10
FFB	-5.00E-11	FBB	-6.90E-10	F05	5.00E-11	F45	6.90E-10
FFA	-6.00E-11	FBA	-7.00E-10	F06	6.00E-11	F46	7.00E-10
FF9	-7.00E-11	FB9	-7.10E-10	F07	7.00E-11	F47	7.10E-10
FF8	-8.00E-11	FB8	-7.20E-10	F08	8.00E-11	F48	7.20E-10
FF7	-9.00E-11	FB7	-7.30E-10	F09	9.00E-11	F49	7.30E-10
FF6	-1.00E-10	FB6	-7.40E-10	F0A	1.00E-10	F4A	7.40E-10
FF5	-1.10E-10	FB5	-7.50E-10	F0B	1.10E-10	F4B	7.50E-10
FF4	-1.20E-10	FB4	-7.60E-10	F0C	1.20E-10	F4C	7.60E-10
FF3	-1.30E-10	FB3	-7.70E-10	F0D	1.30E-10	F4D	7.70E-10
FF2	-1.40E-10	FB2	-7.80E-10	F0E	1.40E-10	F4E	7.80E-10
FF1	-1.50E-10	FB1	-7.90E-10	F0F	1.50E-10	F4F	7.90E-10
FF0	-1.60E-10	FBO	-8.00E-10	F10	1.60E-10	F50	8.00E-10
FEF	-1.70E-10	FAF	-8.10E-10	F11	1.70E-10	F51	8.10E-10
FEE	-1.80E-10	FAE	-8.20E-10	F12	1.80E-10	F52	8.20E-10
FED	-1.90E-10	FAD	-8.30E-10	F13	1.90E-10	F53	8.30E-10
FEC	-2.00E-10	FAC	-8.40E-10	F14	2.00E-10	F54	8.40E-10
FEB	-2.10E-10	FAB	-8.50E-10	F15	2.10E-10	F55	8.50E-10
FEA	-2.20E-10	FAA	-8.60E-10	F16	2.20E-10	F56	8.60E-10
FE9	-2.30E-10	FA9	-8.70E-10	F17	2.30E-10	F57	8.70E-10
FE8	-2.40E-10	FA8	-8.80E-10	F18	2.40E-10	F58	8.80E-10
FE7	-2.50E-10	FA7	-8.90E-10	F19	2.50E-10	F59	8.90E-10
FE6	-2.60E-10	FA6	-9.00E-10	F1A	2.60E-10	F5A	9.00E-10
FE5	-2.70E-10	FA5	-9.10E-10	F1B	2.70E-10	F5B	9.10E-10
FE4	-2.80E-10	FA4	-9.20E-10	F1C	2.80E-10	F5C	9.20E-10
FE3	-2.90E-10	FA3	-9.30E-10	F1D	2.90E-10	F5D	9.30E-10
FE2	-3.00E-10	FA2	-9.40E-10	F1E	3.00E-10	F5E	9.40E-10
FE1	-3.10E-10	FA1	-9.50E-10	F1F	3.10E-10	F5F	9.50E-10
FE0	-3.20E-10	FA0	-9.60E-10	F20	3.20E-10	F60	9.60E-10
FD9	-3.30E-10	F9F	-9.70E-10	F21	3.30E-10	F61	9.70E-10
FDE	-3.40E-10	F9E	-9.80E-10	F22	3.40E-10	F62	9.80E-10
FDD	-3.50E-10	F9D	-9.90E-10	F23	3.50E-10	F63	9.90E-10
FDC	-3.60E-10	F9C	-1.00E-09	F24	3.60E-10	F64	1.00E-09
FDB	-3.70E-10	F9B	-1.01E-09	F25	3.70E-10	F65	1.01E-09
FDA	-3.80E-10	F9A	-1.02E-09	F26	3.80E-10	F66	1.02E-09
FD9	-3.90E-10	F99	-1.03E-09	F27	3.90E-10	F67	1.03E-09
FD8	-4.00E-10	F98	-1.04E-09	F28	4.00E-10	F68	1.04E-09
FD7	-4.10E-10	F97	-1.05E-09	F29	4.10E-10	F69	1.05E-09
FD6	-4.20E-10	F96	-1.06E-09	F2A	4.20E-10	F6A	1.06E-09
FD5	-4.30E-10	F95	-1.07E-09	F2B	4.30E-10	F6B	1.07E-09
FD4	-4.40E-10	F94	-1.08E-09	F2C	4.40E-10	F6C	1.08E-09
FD3	-4.50E-10	F93	-1.09E-09	F2D	4.50E-10	F6D	1.09E-09
FD2	-4.60E-10	F92	-1.10E-09	F2E	4.60E-10	F6E	1.10E-09
FD1	-4.70E-10	F91	-1.11E-09	F2F	4.70E-10	F6F	1.11E-09
FD0	-4.80E-10	F90	-1.12E-09	F30	4.80E-10	F70	1.12E-09
FCF	-4.90E-10	F8F	-1.13E-09	F31	4.90E-10	F71	1.13E-09
FCE	-5.00E-10	F8E	-1.14E-09	F32	5.00E-10	F72	1.14E-09
FCD	-5.10E-10	F8D	-1.15E-09	F33	5.10E-10	F73	1.15E-09
FCC	-5.20E-10	F8C	-1.16E-09	F34	5.20E-10	F74	1.16E-09
FCB	-5.30E-10	F8B	-1.17E-09	F35	5.30E-10	F75	1.17E-09
FCA	-5.40E-10	F8A	-1.18E-09	F36	5.40E-10	F76	1.18E-09
FC9	-5.50E-10	F89	-1.19E-09	F37	5.50E-10	F77	1.19E-09
FC8	-5.60E-10	F88	-1.20E-09	F38	5.60E-10	F78	1.20E-09
FC7	-5.70E-10	F87	-1.21E-09	F39	5.70E-10	F79	1.21E-09
FC6	-5.80E-10	F86	-1.22E-09	F3A	5.80E-10	F7A	1.22E-09
FC5	-5.90E-10	F85	-1.23E-09	F3B	5.90E-10	F7B	1.23E-09
FC4	-6.00E-10	F84	-1.24E-09	F3C	6.00E-10	F7C	1.24E-09
FC3	-6.10E-10	F83	-1.25E-09	F3D	6.10E-10	F7D	1.25E-09
FC2	-6.20E-10	F82	-1.26E-09	F3E	6.20E-10	F7E	1.26E-09
FC1	-6.30E-10	F81	-1.27E-09	F3F	6.30E-10	F7F	1.27E-09
		F80	-1.28E-09				

Table 2 indicates coarse turning frequency correction value for the pulling range of $\pm 1.2 \times 10^{-7}$ full scale.

Windows Terminal		windows Terminal		Windows Terminal		Windows Terminal	
Frequency		Frequency		Frequency		Frequency	
Negative Adjustment				Positive Adjustment			
COO	0.00E+00	CCO	-6.40E-08	COO	0.00E+00	CAO	6.40E-08
CFF	-1.00E-09	CBF	-6.50E-08	C01	1.00E-09	C41	6.50E-08
CFE	-2.00E-09	CBE	-6.60E-08	C02	2.00E-09	C42	6.60E-08
CFD	-3.00E-09	CBD	-6.70E-08	C03	3.00E-09	C43	6.70E-08
CFC	-4.00E-09	CBC	-6.80E-08	C04	4.00E-09	C44	6.80E-08
CFB	-5.00E-09	CBB	-6.90E-08	C05	5.00E-09	C45	6.90E-08
CFA	-6.00E-09	CBA	-7.00E-08	C06	6.00E-09	C46	7.00E-08
CF9	-7.00E-09	CB9	-7.10E-08	C07	7.00E-09	C47	7.10E-08
CF8	-8.00E-09	CB8	-7.20E-08	C08	8.00E-09	C48	7.20E-08
CF7	-9.00E-09	CB7	-7.30E-08	C09	9.00E-09	C49	7.30E-08
CF6	-1.00E-08	CB6	-7.40E-08	COA	1.00E-08	C4A	7.40E-08
CF5	-1.10E-08	CB5	-7.50E-08	COB	1.10E-08	C4B	7.50E-08
CF4	-1.20E-08	CB4	-7.60E-08	COC	1.20E-08	C4C	7.60E-08
CF3	-1.30E-08	CB3	-7.70E-08	COD	1.30E-08	C4D	7.70E-08
CF2	-1.40E-08	CB2	-7.80E-08	COE	1.40E-08	C4E	7.80E-08
CF1	-1.50E-08	CB1	-7.90E-08	COF	1.50E-08	C4F	7.90E-08
CFO	-1.60E-08	CB0	-8.00E-08	C10	1.60E-08	C50	8.00E-08
CEF	-1.70E-08	CAF	-8.10E-08	C11	1.70E-08	C51	8.10E-08
CEE	-1.80E-08	CAE	-8.20E-08	C12	1.80E-08	C52	8.20E-08
CED	-1.90E-08	CAD	-8.30E-08	C13	1.90E-08	C53	8.30E-08
CEC	-2.00E-08	CAC	-8.40E-08	C14	2.00E-08	C54	8.40E-08
CEB	-2.10E-08	CAB	-8.50E-08	C15	2.10E-08	C55	8.50E-08
CEA	-2.20E-08	CAA	-8.60E-08	C16	2.20E-08	C56	8.60E-08
FE9	-2.30E-08	CA9	-8.70E-08	C17	2.30E-08	C57	8.70E-08
CE8	-2.40E-08	CA8	-8.80E-08	C18	2.40E-08	C58	8.80E-08
CE7	-2.50E-08	CA7	-8.90E-08	C19	2.50E-08	C59	8.90E-08
CE6	-2.60E-08	CA6	-9.00E-08	C1A	2.60E-08	C5A	9.00E-08
CE5	-2.70E-08	CA5	-9.10E-08	C1B	2.70E-08	C5B	9.10E-08
CE4	-2.80E-08	CA4	-9.20E-08	C1C	2.80E-08	C5C	9.20E-08
CE3	-2.90E-08	CA3	-9.30E-08	C1D	2.90E-08	C5D	9.30E-08
CE2	-3.00E-08	CA2	-9.40E-08	C1E	3.00E-08	C5E	9.40E-08
CE1	-3.10E-08	CA1	-9.50E-08	C1F	3.10E-08	C5F	9.50E-08
CEO	-3.20E-08	CA0	-9.60E-08	C20	3.20E-08	C60	9.60E-08
CDF	-3.30E-08	C9F	-9.70E-08	C21	3.30E-08	C61	9.70E-08
CDE	-3.40E-08	C9E	-9.80E-08	C22	3.40E-08	C62	9.80E-08
CDD	-3.50E-08	C9D	-9.90E-08	C23	3.50E-09	C63	9.90E-08
CDC	-3.60E-08	C9C	-1.00E-07	C24	3.60E-08	C64	1.00E-08
CDB	-3.70E-08	C9B	-1.01E-07	C25	3.70E-08	C65	1.01E-08
CDA	-3.80E-08	C9A	-1.02E-07	C26	3.80E-08	C66	1.02E-07
CD9	-3.90E-08	C99	-1.03E-07	C27	3.90E-08	C67	1.03E-07
CD8	-4.00E-08	C98	-1.04E-07	C28	4.00E-08	C68	1.04E-07
CD7	-4.10E-08	C97	-1.05E-07	C29	4.10E-08	C69	1.05E-07
CD6	-4.20E-08	C96	-1.06E-07	C2A	4.20E-08	C6A	1.06E-07
CD5	-4.30E-08	C95	-1.07E-07	C2B	4.30E-08	C6B	1.07E-07
CD4	-4.40E-08	C94	-1.08E-07	C2C	4.40E-08	C6C	1.08E-07
CD3	-4.50E-08	C93	-1.09E-07	C2D	4.50E-08	C6D	1.09E-07
CD2	-4.60E-08	C92	-1.10E-07	C2E	4.60E-08	C6E	1.10E-07
CD1	-4.70E-08	C91	-1.11E-07	C2F	4.70E-08	C6F	1.11E-07
CD0	-4.80E-08	C90	-1.12E-07	C30	4.80E-08	C70	1.12E-07
CCF	-4.90E-08	C8F	-1.13E-07	C31	4.90E-08	C71	1.13E-07
CCE	-5.00E-08	C8E	-1.14E-07	C32	5.00E-08	C72	1.14E-07
CCD	-5.10E-08	C8D	-1.15E-07	C33	5.10E-08	C73	1.15E-07
CCC	-5.20E-08	C8C	-1.16E-07	C34	5.20E-08	C74	1.16E-07
CCB	-5.30E-08	C8B	-1.17E-07	C35	5.30E-08	C75	1.17E-07
CCA	-5.40E-08	C8A	-1.18E-07	C36	5.40E-08	C76	1.18E-07
CC9	-5.50E-08	C89	-1.19E-07	C37	5.50E-08	C77	1.19E-07
CC8	-5.60E-08	C88	-1.20E-07	C38	5.60E-08	C78	1.20E-07
CC7	-5.70E-08	C87	-1.21E-07	C39	5.70E-08	C79	1.21E-07
CC6	-5.80E-08	C86	-1.22E-07	C3A	5.80E-08	C7A	1.22E-07
CC5	-5.90E-08	C85	-1.23E-07	C3B	5.90E-08	C7B	1.23E-07
CC4	-6.00E-08	C84	-1.24E-07	C3C	6.00E-08	C7C	1.24E-07
CC3	-6.10E-08	C83	-1.25E-07	C3D	6.10E-08	C7D	1.25E-07
CC2	-6.20E-08	C82	-1.26E-07	C3E	6.20E-08	C7E	1.26E-07
CC1	-6.30E-08	C81	-1.27E-07	C3F	6.30E-08	C7F	1.27E-07
		C80	-1.28E-07				

2.7 Reading back the Frequency Center Values

Except for the HPFRS-01 model, coarse and fine frequency correction values can be read back through the following commands:

L06 <CR> for coarse adjustment
 L0A <CR> for fine adjustment

2.8 Rubidium Identification

Except for the HPFRS model, after power on, the Rubidium clock identifies itself through the RS-232. This feature can be useful for testing the serial link between the Rubidium clock and the PC.

The format of the returned string is typically the following:

TNT/Model Rb Version Date Checksum

Model: Rubidium model (MCFRS/LPFRS/RMO etc...)
Version: Software version
Date: Software date
Checksum: Checksum indicator for the factory

This format can be changed at anytime without notice. The provided information is not guaranteed. The MCFRS-01 and MCFRS-02 models typically return "MCFRS-01" after identification. The same string is returned if the following "Version" command is sent by RS-232 to the Rubidium clock:

V <CR>

The command should be sent in UPPER CASE. <CR> means: Carriage Return (ASCII decimal code 13).

3. RS-232 ADAPTER CIRCUIT

In most cases, the serial PC interface accepts the 0-5V level and a direct connection can be made. If the standard 0-5V level is not working, please use this circuit scheme:

Connect to Rubidium clock's serial port according to this pin function layout

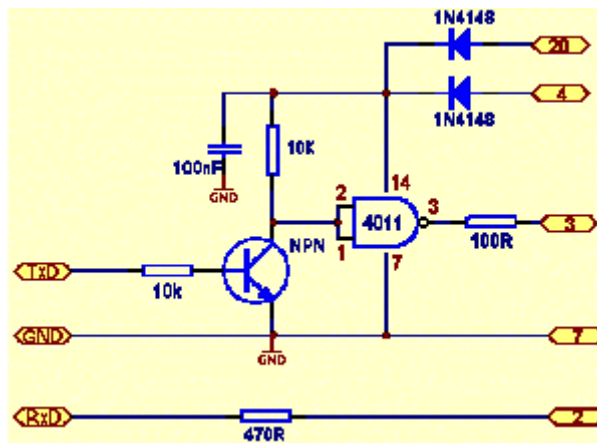

Connect to PC's DB25 serial port

4. RUBIDIUM ASCII-CODE CONVERSION TABLE FOR COMMUNICATIONS

The Rubidium clock will only interpret the ASCII codes listed below. Any other code or wrong command syntax is refuted through a “?” character after the "Execute command" code (Carriage Return).

Character / Code	Decimal weight	Hexadecimal weight	Usage
<CR>	13 (d)	0x0D (h)	Execute command
0	48 (d)	0x30 (h)	Hexa value
1	49 (d)	0x31 (h)	Hexa value
2	50 (d)	0x32 (h)	Hexa value
3	51 (d)	0x33 (h)	Hexa value
4	52 (d)	0x34 (h)	Hexa value
5	53 (d)	0x35 (h)	Hexa value
6	54 (d)	0x36 (h)	Hexa value
7	55 (d)	0x37 (h)	Hexa value
8	56 (d)	0x38 (h)	Hexa value
9	57 (d)	0x39 (h)	Hexa value
A	65 (d)	0x41 (h)	Hexa value
B	66 (d)	0x42 (h)	Hexa value
C	67 (d)	0x43 (h)	Hexa value / Center freq. command
D	68 (d)	0x44 (h)	Hexa value
E	69 (d)	0x45 (h)	Hexa value
F	70 (d)	0x46 (h)	Hexa value / Fine adjust. command
?	63 (d)	0x3F (h)	Invalid command (returned)
L	76 (d)	0x4C (h)	Read-back command
M	77 (d)	0x4D (h)	Monitoring command
V	86 (d)	0x56 (h)	Identification command

5. MICROSOFT WINDOWS 95/98 HYPERTERMINAL SETUP CONFIGURATION

Please verify that the Hyperterminal is installed on your system in the start menu as follows:
Start / Programs / Accessories / Hyperterminal

If not, first install the Hyperterminal program in the Configuration Panel as follows:
Add program / Windows Installation / Communication / Option / Hyperterminal

Once the Hyperterminal is installed, run it and follow these instructions:

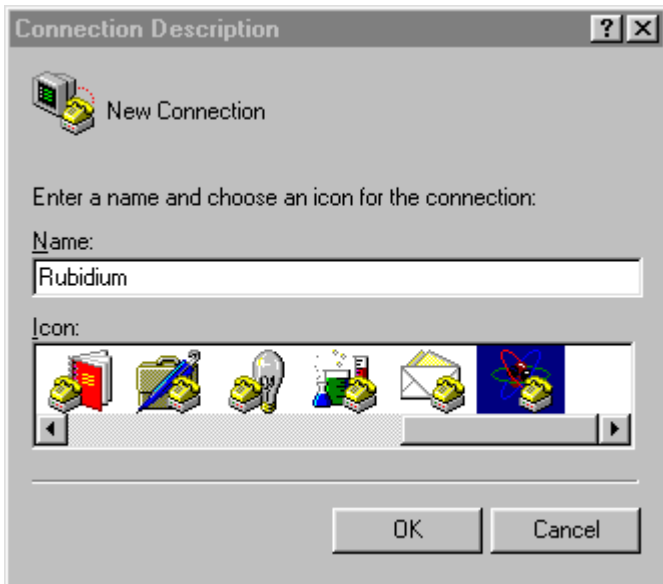

Figure 5.1: Connection Description

Step 1: Create a new connection.

Call it "Rubidium", for example, in the "Name" field.

You can choose the Atom icon which is the last one on the list.

This will create a profile for future access for the Rubidium clock monitoring



Figure 5.2: Port Selection

Step 2: Specify the communication port hardware.

Omit the three first choices.

Choose the right serial port in the "Connect using" field

If you want to communicate through the serial port 1, please choose "Direct to Com1"

If you want to communicate through the serial port 2, please choose "Direct to Com2"

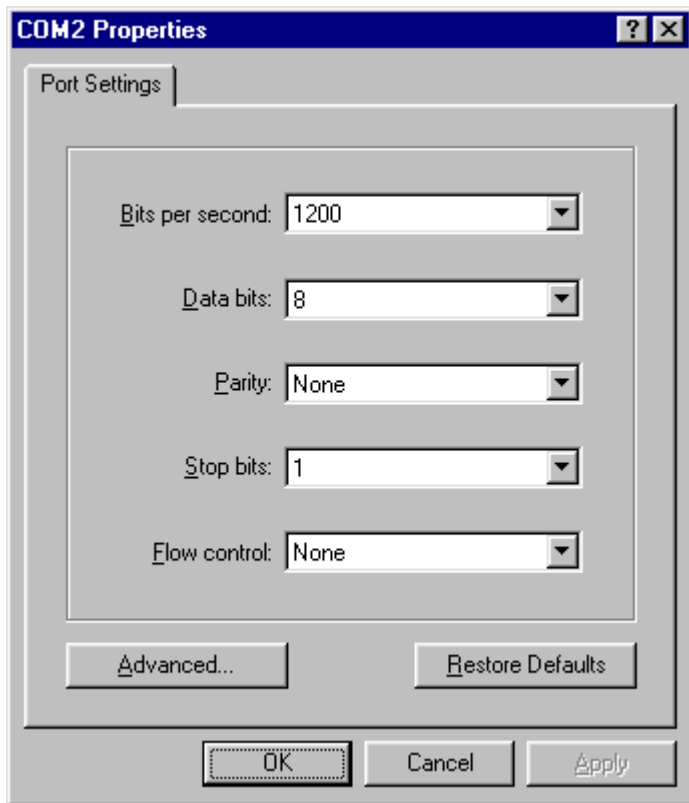

Step 3: Enter the following serial data transfer parameters:

- Baud rate: 1200 Bits per seconds
- Data bits: 8 bits
- Parity: None
- Stop bits: 1
- Flow control: None

Then click OK.

You are now ready to communicate with the Rubidium clock.

Figure 5.3: COMx Properties