

# Patented SRO-100 SynClock+<sup>®</sup>

## Auto-Adaptive GPS/GNSS SmarTiming+<sup>®</sup> Technology



### Applications

Telecom | Navigation | Broadcast  
Defense | Instrument

### KEY FEATURES

- Single power supply voltage : 11 - 16V or 20 - 32V
- Small volume : 11 in<sup>3</sup> (2.78x4x1")
- Frequency offset over temp. range : ± 1E-10
- Short-term stability : 1E-12 / 100 sec.
- Industry's first SmarTiming+<sup>®</sup> technology
  - REF locking resolution : 1 ns
  - REF disciplining/filtering/controlling : Auto adaptive(a)
  - *Smart loop time constant* : 1000 - 100,000 sec
  - *E1/T1 jitter & wander* : ITU-T G.823/824
  - REF locking mode (user settable) : Sync(b) or Track(c)
  - REF types (PRS(d)/Stratum 1 source) : GPS, Cesium, E1/T1, LORAN-C, Maser
  - OUT frequency accuracy/stability : 1E-12, typical
  - *PRS(d)/Stratum 1 locked* : <5E-11/month
  - *Holdover (No PRS(d))*
  - OUT time accuracy/stability : <50ns
  - *GPS locked* : <2µs/48 hr or <1µs/24 hr
  - *Holdover (no GPS)*
  - Standards compliance : ANSI T1.101, Stratum 1 / 2, GR-1244
  - PRS(d) locked/unlocked : ITU-T G.811/G.812, PRC, Type II CDMA IS-95, UMTS 3GPPS 25.104
- Low warm-up current : < 1.2A
- Ultra low aging : < 5E-11/ month
- Ultra low phase noise output : 10MHz -100dBc @ 10 Hz
- High frequency LV CMOS output : 60MHz
- RS232 standard interface : Control & monitoring commands, 9600 b/s

### Notes

- (a) Request our **SmarTiming+<sup>®</sup> Technology White Paper** to compare performance at [clocksupport@orolia.com](mailto:clocksupport@orolia.com)
- (b) REF/OUT phase alignment
- (c) REF/OUT frequency alignment
- (d) PRS: Stratum 1 Primary Reference Source such as GPS, Cesium, E1/T1, LORAN-C, Maser

## SPECIFICATIONS

### ELECTRICAL

Spec		Smart SRO-100 SynClock+®			
Type		Standard	Options		
RFOUT Frequency		10 MHz	Optional 5 MHz, 15 MHz <b>(ordering code: 5M or 15M)</b>		
Frequency Change Operating temperature range (Thermal chamber with air flow)		< 1E-10 -20°C to +60°C	-30 to 65°C <b>(ordering code: E)</b> -40 to 65°C <b>(ordering code: E40)</b> -10 to 60°C <b>(ordering code: LP)</b>		
Frequency Accuracy @ Shipment		< 5E-11 (+25°C), typical			
Aging (After 3 months of continuous operation)		< 5E-11 / month (typical: 3E-11 / month)	< 3E-11 / month or 2E-10 / year <b>(ordering code: A)</b> (typical: ±1E-11 / month)		
Short Term Stability			(ordering code: S)		
	1s	3E-11	1E-11		
	10s	1E-11	3 E-12		
	100s	3E-12	1E-12		
Phase Noise (dBc/Hz) (RFOUT 10 MHz)			<b>(ordering code: S)</b>		
	1 Hz	-75	-80		
	10 Hz	-95	-100		
	100 Hz	-125			
	1k Hz	-145			
	10K Hz	-145			
Frequency Retrace  (In stable temperature, gravity, pressure & magnetic field conditions)	Off/On	< 5E-11 24 hr / 1 hr			
Warm-up Time @ +25°C Frequency stability		12 min 5E-10	7 min 5E-10 <b>(ordering code: F)</b>	<4min 5E-10 <b>(ordering code: FE)</b>	25 min 5E-10 <b>(Low Power ordering code: LP)</b>
Analog Frequency Adjustment Tolerance [An external voltage (0-5 VDC) can be applied to pin 6 (FA). The cursor pin of a 10 kΩ variable resistor placed between pin 7 and GND can provide this voltage. If not used, pin 7 must be floating]		5 x 10 <sup>-9</sup> ±20%			
Digital Frequency Adjustment Internal crystal oscillator freq. Resolution (Through RS-232 commands)		±1.67E-8 60MHz 5.12E-13			
RFOUT Output level Output impedance Harmonics Spurious f0 ± 100kHz 60MHz sub-harmonics		Sine wave 0.5 Vrms (± 10% / 50Ω) 50Ω ±20% < -25dBc < -80dBc < -45dBc	< -30dBc (ordering code: 30dbc)		
60MHz Out		Square wave 3.3V LV CMOS	10 MHz Square wave 3.3V (ordering code: LVCMOS)		
Supply Voltage (DC)		24V (20 to 32 V)	12V (11.2 to 16 V) (ordering code: 12V)		
Max Power Supply Ripple		< 50 mV peak to peak (from 1Hz to 1 MHz frequency band)			

## ELECTRICAL

Spec	Smart SRO-100 SynClock+®			
Input Power  Warm up @+25°C (typical) 0°C +25°C +60°C	<28W @12V or <35W @ 24V <14 W < 11 W < 7 W		With following options  (F/E)                      (FE)                      (LP) <40 W                      <50 W                      <17W (24V only)                      (24V only)	
Communication Interface  Protocol speed Compatible with	RS-232 commands for control & monitoring (see commands below) Timing and locking control functions VMGA messages 9600, n, 8, 1 SRO-100 model			
Conformal coating	None		Yes (ordering code: CC)	
Reverse Voltage Protection	< -40V (up to -40V on power input / no damage)			

## SMARTIMING+® DISCIPLINING & FILTERING

Spec	Smart SRO-100 SynClock+®			
PPSREF Level  Reference types Disciplining & filtering Disciplining mode Architecture Model	CMOS 0-5V or 0-3.3V rising edge GPS, E1, T1, Cesium, LORAN-C, Maser, etc Auto-adaptive through SmartTiming+® technology (request white paper) Sync (phase alignment) or Track (frequency alignment)			
GPS Receiver Control  T-RAIM Position hold	(Request GPS/SRO-100 Connectivity AppNote) Auto-configured at startup, if supported by GPS Auto-configured at startup,			
PPSOUT Output Level  Current	CMOS 0-5V +20 mA sink/source			
PPSOUT Adjustable Duty Cycle Pulse Width (PW)	133 ns step from 0 to 1sec			
PPSOUT to PPSREF Sync Error Conditions (Sync Mode)	< 50 ns No PPSRef noise, ± 1°C temp fluctuations			
PPSOUT to PPSREF (DE) Programmable delay (Track mode)	0 to 1s in 133ns/step			
PPSOUT Holdover Time Stability  Temperature window (After learning phase > 10 τ)	< 1μs / 24 hr < 7μs / 1 week Within ±2°C	< 3μs / 24 hr  Within 20°C	< 7μs / 24 hr  Within 40°C	
Smart Loop Time Constant  Phase/Frequency User settable	Auto-adaptive 1,000 to 100,000 sec Sync/Trak mode RS-232 command interface			

## ENVIRONMENTAL

Spec	Smart SRO-100 SynClock+®			
Magnetic Field Sensitivity	< 2E-10 / Gauss in worst axis			
Storage Temperature	- 55°C to + 85°C			
Humidity	GR-CORE-63, Section 5.1.2			
Operating Vibration	GR-CORE-63, Section 5.4.2 Random and Sinusoidal MIL-PRF- 28800F, Class 3, 4	Ruggedized (ordering code: VIB) Profile: MIL-STD-810F, Method 514.5, Category 24 Average acceleration: 7.7g rms Duration: 1 hour/axis Axis: on each X/Y/Z axis For longer vibration periods , please contact Factory		
Shock	Survival: 40g / 11ms			
Helium concentration sensitivity	< 1E-10 per ppm of Helium concentration change			
G-Tip-Over Test	< 2E-10 / g in worst axis			
Shielding	Soldered packaging (ordering code: SH) M3x8 screws & brass washer (ordering code: M3)			
MTBF	138533 Hours with 25°C box operations (25°C baseplate or 25°C airflow > 20m / sec) With ON/OFF cycles over lifetime limited to 1000 cycles			

## PHYSICAL

Spec	Smart SRO-100 SynClock+®
Size (L x W x H)	4" x 2.78" x 1" (101.6 x 70.61 x 25.4 mm)
Weight	234g (8.25oz)
Mounting & Mechanical Layout	See drawings below
Connector	Male D-sub 25 pins (see drawing below)

## MODEL ORDERING INSTRUCTIONS

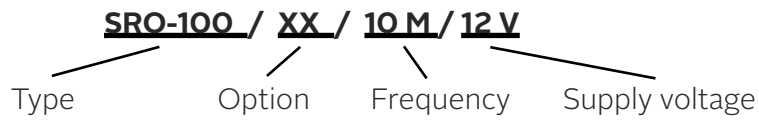

## KEY OPERATIONAL PRINCIPLES

The smart SRO-100 SynClock+® uses SmarTiming+® technology. It auto-adaptively locks multi-vendor Stratum-1 references such as GPS, Cesium, LORAN-C, CDMA and E1/T1 at industry's first 1ns resolution for the highest performance level, and generates a perfectly aligned 1PPS output signal (PPSOUT) and time of day (TOD) information.

As illustrated in Fig. 1 below, the smart SRO-100 has two basic modes of operation: "Track" and "Sync". "Track" is used for frequency alignment while "Sync" is used for phase alignment applications.

In "Track" mode, the smart SRO-100 uses an external PPS reference (PPSREF) to align the frequency of the SRO-100. The frequency alignment is computed by an internal phase-time error signal that is generated by an internal PPS signal (PPSINT), which measures the signal at 1 ns resolution through its SmarTiming+® technology. The PPSINT then aligns the PPSREF phase.

In the "Sync" mode, the smart SRO-100 phase aligns the PPSOUT to the PPSREF with the PPSINT reference signal, which uses SmarTiming+® algorithm to 1) compare the PPSOUT and PPSREF signals at 1ns resolution within a +/-500ns dynamic range and 2) auto-adaptively align them.

The smart SRO-100 has also the capability to dynamically analyze the stability of the PPSREF signal through the excellent mid-term frequency stability of the Rubidium technology. Thus, the 1PPS reference of a Stratum-1 source such as GPS can be directly fed to smart SRO-100 without specific analysis of the internal optimization parameters of the GPS engine - i.e., number of satellites in view, signal to noise ratio, etc.

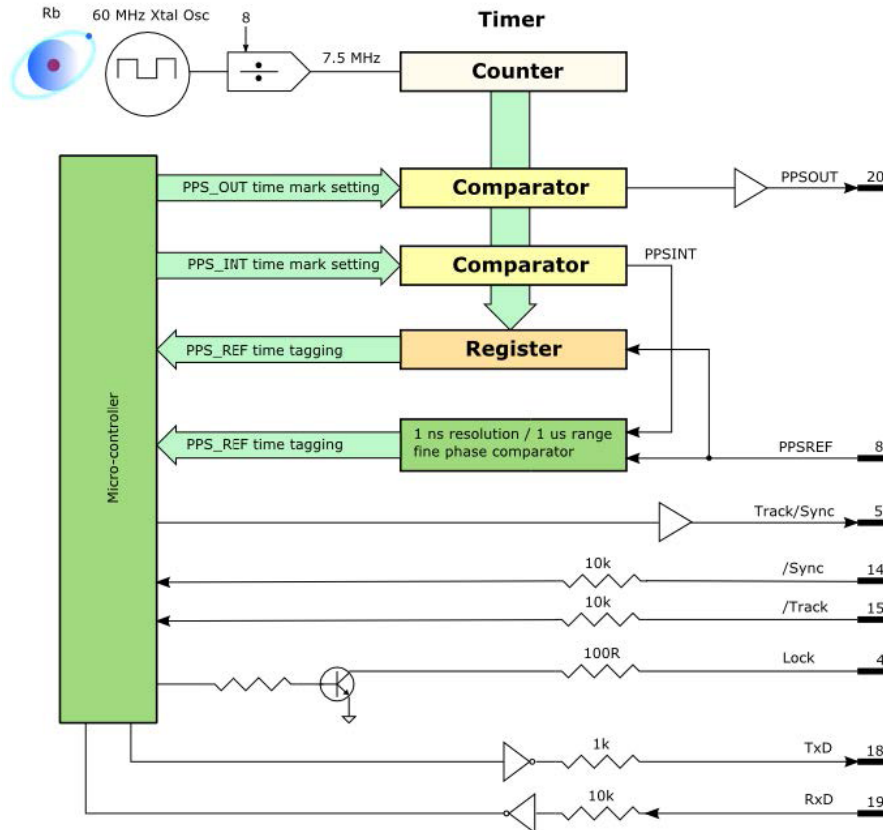

Fig.1: SmarTiming+® Control Block Diagram

As illustrated in Fig. 2 below, the “Track” mode aligns the PPSINT to the PPSREF within 133ns. After about 10τ, the PPSINT is perfectly aligned to the PPSREF.

The smart SRO-100 is also capable to perfectly align the PPSOUT to the PPSREF or to adjust the PPSOUT from 0-1s with a 133ns resolution. This time adjustment can be programmed through the RS232 interface. After a descending edge of the “Sync” signal, the PPSOUT will be aligned to the PPSREF (see figure 2).

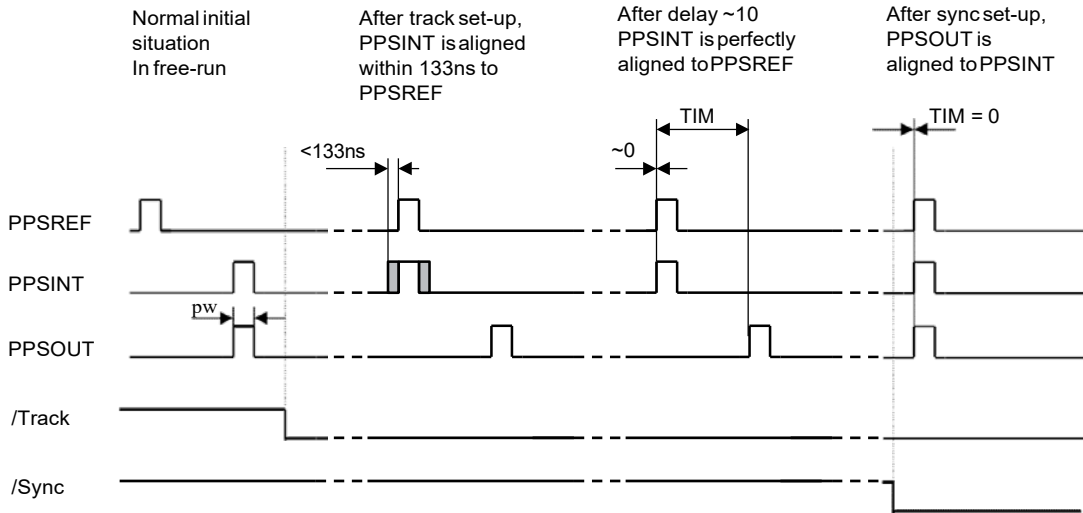

Figure 2 : “Track” & “Sync” Mode

## STANDARD RS-232 CONTROL & MONITORING COMMANDS

The operating and monitoring parameters of the LNRClck-1500 are accessible for read and write operations through the serial RS-232 port (9600 bits/sec., no parity, 1 start bit, 8 data bits, 1 stop bit).

There are 2 basics commands, which are M, Cxxxx

M<CR><LF>: monitors the basic internal signals of the atomic clock.

The returned answer looks like

HH GG FF EE DD CC BB AA <CR> <LF>

Where each returned byte is an ASCII coded hexadecimal value, separated by a <Space> character. All parameters are coded at full scale.

HH: Read-back of the user provided frequency adjustment voltage on pin 6 (0 to 5V)

GG: reserved

FF: peak voltage of Rb-signal (0 to 5V)

EE: DC-Voltage of the photocell (5V to 0V)

DD: varactor control voltage (0 to 5V)

CC: Rb-lamp heating current (Imax to 0)

BB: Rb-cell heating current (Imax to 0) AA: reserved

Cxxxx<CR><LF> \*: output frequency adjustment through the synthesizer, by steps of  $5.12 \times 10^{-13}$ , where xxxx is a signed 16 bits word in hexa coded ASCII. This value is automatically stored in a EEPROM as last frequency which is applied after RESET or power-ON operation.

In Track mode this correction is not in use. The function FCsdddd do the same. But the data format is different.

Note :

\* Warning :: This command is acting into non volatile memory. Numbers of commands sent during the whole unit life time limited to 100'000 in total (all commands cumulated).

## Timing & Locking Control Functions

Using the same data interface, the smart SRO-100 SynClock+® models can accept the following basic ASCII commands: Data is in decimal ASCII code.

Command name	Syntax command	Data field (if any)	Response syntax	Response data (if any)
Identification	<b>ID</b> <CR><LF>	-	<b>TNTSRO</b> -aaa/rr/s.ss <CR><LF>	aaa: 100 rr: revision number s.ss: software version
Serial number	<b>SN</b> <CR><LF>	-	xxxxxx<CR><LF>	xxxxxx : 6 digits serial nbr
Status	<b>ST</b> <CR><LF>	-	<b>s</b> <CR><LF>	s:Status s=0 :warming up s=1 :tracking set-up s=2 :track to PPSREF s=3 :synch to PPSREF s=4 :Free Run. Track OFF s=5 :FR. PPSREF unstable s=6 :FR. No PPSREF s=7 :factory used s=8 :factory used s=9 :fault or Rb OOL
Set Tracking PPSINT - PPSREF	<b>TR</b> x<CR><LF> *	x=0 : Track never * x=1 : Track now x=2 : Track ever * x=3 : Track now + ever * x= ? : Interrogation	x<CR><LF>	x:Tracking commands status x=0 : Track OFF x=1 : Track ON (when Status 9 -> 4
Set Synchronisation PPSOUT – PPSINT	<b>SY</b> x<CR><LF> *	X=0 : Synch. never * x=1 : Synch. now x=2 : Synch. ever * x=3 : Synch. now + ever * x= ? : Interrogation	x<CR><LF>	x:Synch. commands status x=0 : Synch. OFF x=1 : Synch. ON (When Status 1 -> 2)
Set PPSOUT delay	<b>DE</b> ddddddd<CR><LF>	ddddddd=delay by 133ns step. Max 7499999 <b>DE</b> 0000000 :synch to PPSREF	ddddddd<CR><LF>	ddddddd=delay by 133ns step. Max 7499999
Set PPSOUT Pulse Width	<b>PW</b> ddddddd<CR><LF> *	ddddddd=pulse Width by 133ns step. Max 7499999 <b>PW</b> 0000000: no pulse	ddddddd<CR><LF>	ddddddd=Pulse Width by 133ns step. Max 7499999 0000000: no pulse
Time of day	<b>TD</b> <CR><LF>	-	hh:mm:ss<CR><LF>	hh:hours mm:minutes ss:seconds
Set time of day	<b>TD</b> hh:mm:ss<CR><LF>	hh:Hours mm:Minutes ss:seconds	hh:mm:ss<CR><LF>	hh:hours mm:minutes ss:seconds
Date	<b>DT</b> <CR><LF>	-	yyyy-mm-dd	yyyy : year mm : month dd : day
Set date	<b>DT</b> yyyy-mm-dd <CR><LF>	yyyy : year mm : month dd : day	yyyy-mm-dd	yyyy : year mm : month dd : day
Beat every second on serial port.	<b>BT</b> x<CR><LF>	x=0 : Stop beat x=1 : Effective Time interval PPSOUT vs PPSREF x=2 : Phase comparator x=3 : Both x=1 & x=2 x=4 : Beat Time of day x=5 : Beat status x=6 : Beat <CR><LF> x=7 : Beat Date, Time, Status x=A : Beat NMEA \$PTNTA, x=B : Beat NMEA \$PTNTS,B,	ddddddd<CR><LF> or sPPP<CR><LF> or ddddddd sPPP <CR><LF> or hh:mm:ss<CR><LF> s<CR><LF> <CR><LF> yyyy-mm-dd hh:mm:ss s	ddddddd : delay in 133ns step sPPP:phase error in ns s: +/- signe hh:hours mm:minutes ss:secondes s: status  yyyy:year, mm:month,dd:day
Set frequency adjustment	<b>FC</b> sdddd<CR><LF> *	s=+/- signe dddd = limited within range : +32767/-32768 FC ?????? : interrogation	sdddd<CR><LF>	s: +/- signe dddd : frequ. Adj. in 5.12 x 10 <sup>-13</sup> step
Set frequency save. Integral part, when Status = 2, 3	<b>FS</b> x<CR><LF> *	x=0 : never save x=1 : save every 24 hours x=2 : save right now x=3 : save current freq. now x= ? : interrogation	x<CR><LF>	x=0 : never save x=1 : save every 24 hours

Command name	Syntax command	Data field (if any)	Response syntax	Response data (if any)
Set Tracking Window	<b>TW</b> ddd<CR><LF> *	ddd = Half Tracking Window by 133ns step. From 1 to 255 ddd = ??? : interrogation	ddd<CR><LF>	ddd : Half Tracking Window by 133ns step.
Set no Alarm Window	<b>AW</b> ddd<CR><LF> *	ddd = Half no Alarm Window by 133ns step. From 1 to 255 ddd = ??? : interrogation	ddd<CR><LF>	ddd : Half no Alarm Window by 133ns step.
Set tracking phase loop time constant	<b>TC</b> dddddd<CR><LF> *	dddddd = Time constant in seconds (001000 to 999999) TC000000 : change to auto. (<) TC001000 : no change	Dddddd<CR><LF>	dddddd : time constant in seconds
Set module customization	<b>MC</b> sxx [cc...c] <CR><LF> *	s = L : Load parameter s = S : Store parameter ccc..c * s = B : Load start behaviour s = A : Activate msg at start * s = C : Cancel msg at start * s = H : Load Help s = T : Load Data Type xx = OO.FF: msg number, ccc...c : new welcome message, up to 24 characters	cc..c<CR><LF> or d<CR><LF> or xy<CR><LF>	ccc..c : response to MCLxx or to MCHxx.  d : 0, 1 response to MCBdd or xy : Data Type, response to MCTxx, x=0 RAM, x=1 eeprom, x=2 Flash, y=0 Byte, y=1 sByte, y=2 Word, y=3 sWord, ... y=8 string ASCII, y=9 strng binary
Set phase comparator Offset	<b>CO</b> sddd<CR><LF> *	s : +/- signe ddd : limited with range + 127 / - 128 CO???? : interrogation	sddd<CR><LF>	s : +/- signe ddd : offset in approx 1 ns steps
Go fast during beginning of tracking	<b>GF</b> dddd <CR><LF> *	dddd= Time during this mode is active, in seconds DF????? : interrogation	dddd <CR><LF>	dddd: Value stored in eeprom
View PPSRef Sigma	<b>VS</b> <CR><LF>		ddd.d<CR><LF>	ddd.d : Sigma of PPSRef in ns. In tracking, Status 2, 3.
View Time constant	<b>VT</b> <CR><LF>		dddddd<CR><LF>	dddddd : Loop time constant now in use, in ns.
Raw phase adjust	<b>RA</b> sddd<CR><LF>	s : +/- signe ddd : limited with range + 127 / - 128	sddd <CR><LF>	s : +/- signe ddd : raw phase just asked in 133 ns steps
Reset micro controller	<b>RESET</b> <CR><LF>			(Identification & welcome message, GPS binary)

\*Warning : These commands are acting into non volatile memory. Numbers of commands sent during the whole unit life time limited to 10'000 in total (all commands cumulated) But TR1 followed by TRO and SY1 followed by SYO don't write in NVM

## Pin-Out Status Levels

PIN # 4 & 5 STATUS LEVELS			
Status	Pin # 4 Xtal not locked to Rb line	Pin # 5 Track/Synch alarm	
	Rb lock (open collector)	In Track Mode (TTL + 1K)	In Synch Mode (TTL + 1K)
s=0 :warming up	Low (<.2 V / 5 mA)	High	High
s=1 :tracking set-up	High	High	High
s=2 :track to PPSREF	High	Low	High
s=3 :synch to PPSREF	High	High	Low
s=4 :Free Run. Track OFF	High	High	High
s=5 :FR. PPSREF unstable	High	High	High
s=6 :FR. No PPSREF	High	High	High
s=7 :factory used	High	High	High
s=8 :factory used	High	High	High
s=9 :fault or Rb OOL	Low (<.2 V / 5 mA)	High	High



## NMEA 0183 Format (BTA, BTB)

**\$PTNTA**,yyyyymmddhhnnss,q,**T3**,rrrrrr,sfff,s,x,y\*CS<CR><LF>

yyyy: year; mm: month; dd: day; hh: hour; nn: minute; ss: second; q: quality, 0: Rb line not locked, 1: Free Run, 2: Disciplined; T3: format descriptor; rrrrrr: effective time interval PPSOUT vs PPSREF; sfff: phase comparator; s: Status; x,y: reserved; CS: checksum.

**\$PTNTS**,B,s,ffff,iiii,aaaa,x,y,s,cccc,ggg,gg,x,y\*CS<CR><LF>

s: Status; ffff: current frequency; iiiii: holdover frequency; aaaa: average frequency on 24 hours; x,y: reserved; ccccc: loop time constant; ggg,gg: sigma; x,y: reserved; CS: checksum.

## PIN-OUT DESCRIPTION

Pin nbr.	SRO-100	Recommendation	Dir
1	12V(11.2 to 16) or 24V (20 to 32)		Input
2	12V(11.2 to 16) or 24V (20 to 32)		Input
3	GND		Ret
4	Rb lock (open collector) (lock=open)		Output
5	Track/Synch Alarm (TTL+1K) (lock=OV)		Output
6	FA (analog frequency adjust input)	Let float if not used	Input
7	Vref out (+5V internal reference)	I <sub>max</sub> = 1mA	Output
8	PPSREF (reference time pulse)	Let float if not used	Input
9	NC (Factory use or diagnostics)		Output
10	GND		Ret
11	NC (For future use)		Output
12	NC (For future use)	Let float	Input
13	6OM (60MHz square 3.3V output) or (10MHz square 3.3V; option LVCMOS)		Output
14	/Sync (synchronize PPSOUT to PPSREF)	Let float if not used	Input
15	/Track (PPSREF phase tracking)	Let float if not used	Input
16	NC (Factory use or diagnostics)	Let float	In-Out
17	/Reset (SRO-102 micro controller)	Let float if not used	Input
18	TxD (RS232 Transmit 0-5V)		Output
19	RxD (RS232 Receive 0-5V)	Let float if not used	Input
20	PPSOUT (output time pulse from internal clock)		Output
21	NC (For future use)	Let float	Input
22	GND		Ret
23	GND		Ret
24	RFOUT (5 or 10 or 15MHz sinus 7dBm into 50Ω)		Output
25	GND		Ret

## MOUNTING & MECHANICAL LAYOUT

Heat sink options:

- 1) Mount the SRO-100 on a copper ground PCB with the provided thermal pad or thermal paste in between and a base plate under the PCB
- 2) Mount the SRO-100 against a system chassis using the 4xM3 screws with the provided thermal pad or thermal paste in between and wire bridge the D-Sub connector
- 3) Mount a radiator on top of the SRO-100 with the provided thermal pad or thermal paste in between, if no base plate is available

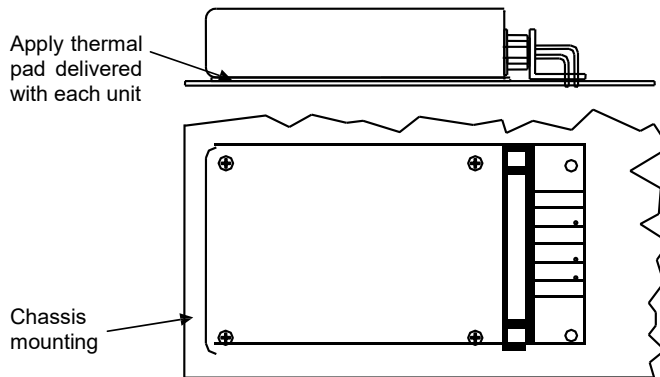

### Mechanical Layout & Dimensions (SRO-100)

All dimensions in inch (") and the pictures are not to scale.

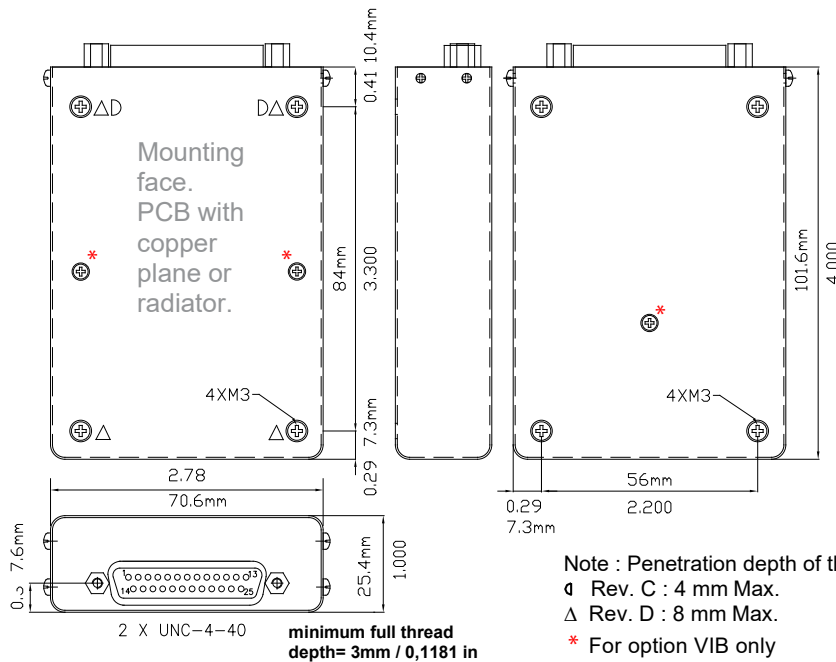

### Option M3

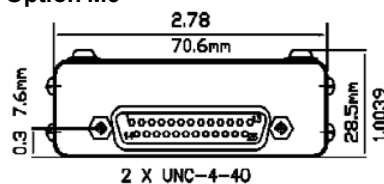

### Connector Front View (SRO-100)

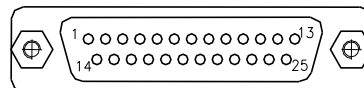

Male D-Sub 25 pins